



BEFARD XP
VACUUM GRIPPER SERIES

BEFARD XP

BEFARD suction cups are available in various variants differing by lifting capacity and number of suction cups. The individual variants of BEFARD suction cups are units suitable for various needs of the users.

FEATURES OF BEFARD VACUUM GRIPPER:

- manual rotation by 360°, interlock for rotation by 45° or 90° and additional interlocks,
- two independent vacuum circuits, each secured,
- integrated vacuum measurement and monitoring device,
- manual stepless tilting,
- easy individual configuration of suction cups, without using any specialized tools,
- the set includes a **remote control** for vacuum and charger with the battery charging indicator

TECHNICAL PARAMETERS

Vacuum system:	Double-circuit
Number of suction cups:	4, 6, 8, 10, 12 or 14
Suction cups:	Ø 310 mm
Min/max vacuum:	-0,6/-0,8 bars
Power supply:	12 V battery
Lifting capacity:	4 suction cups: 300 kg 6 suction cups: 450 kg 8 suction cups: 600 kg 10 suction cups: 800 kg 12 suction cups: 900 kg 14 suction cups: 1000 kg

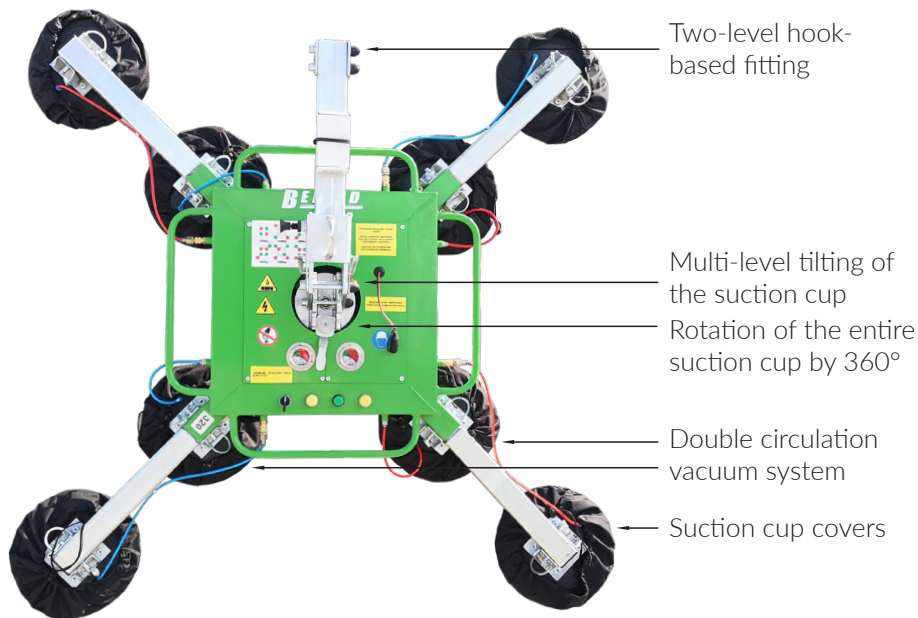

Charger:

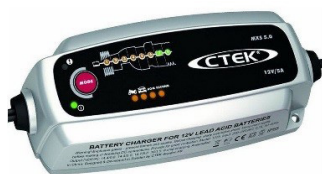

Wireless remote control:



Gripper height:

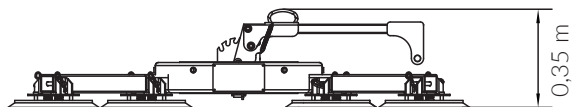

BEFARD XP 300

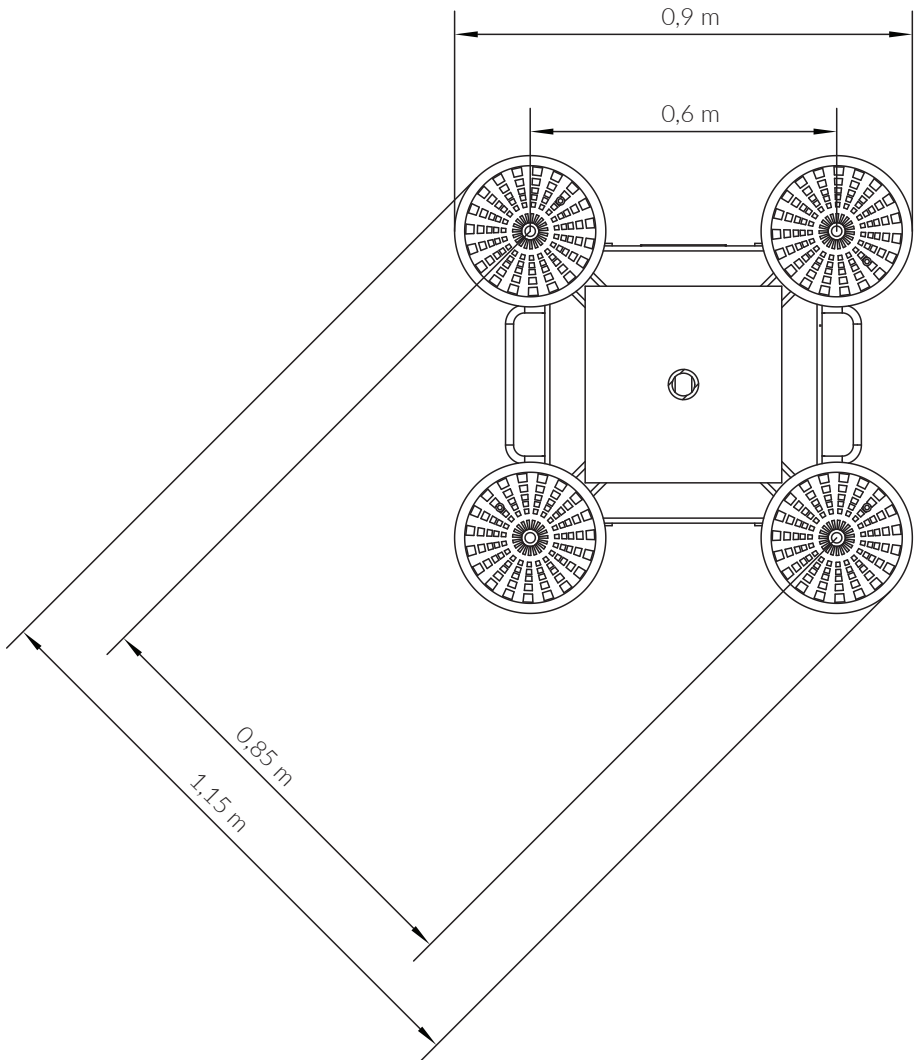

Lifting capacity:
300 kg



Number of
suction cups: 4



BEFARD XP 600

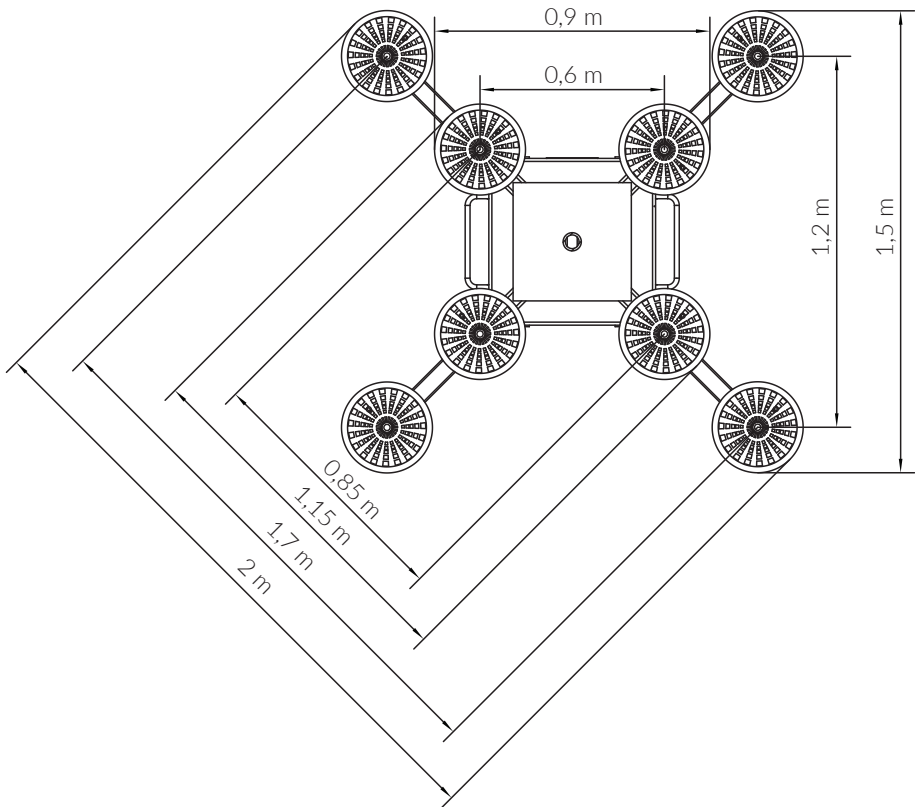

Lifting capacity:
600 kg



Number of
suction cups: 8



BEFARD XP 800

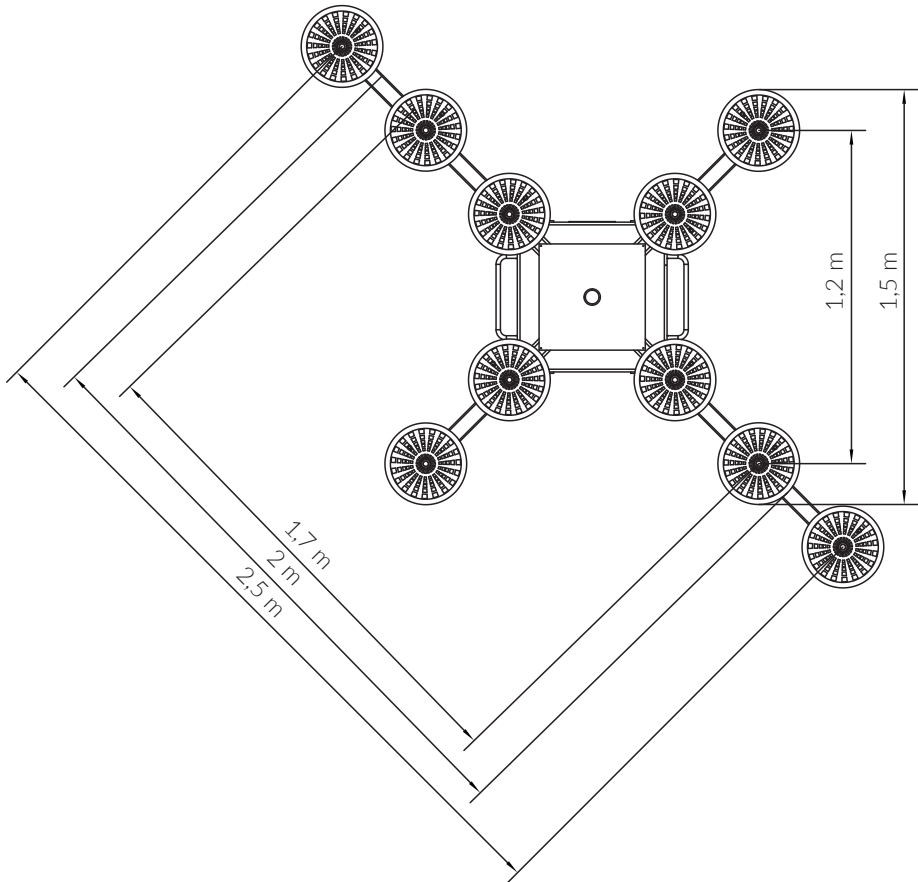

Lifting capacity:
800 kg



Number of
suction cups: 10



BEFARD XP 900

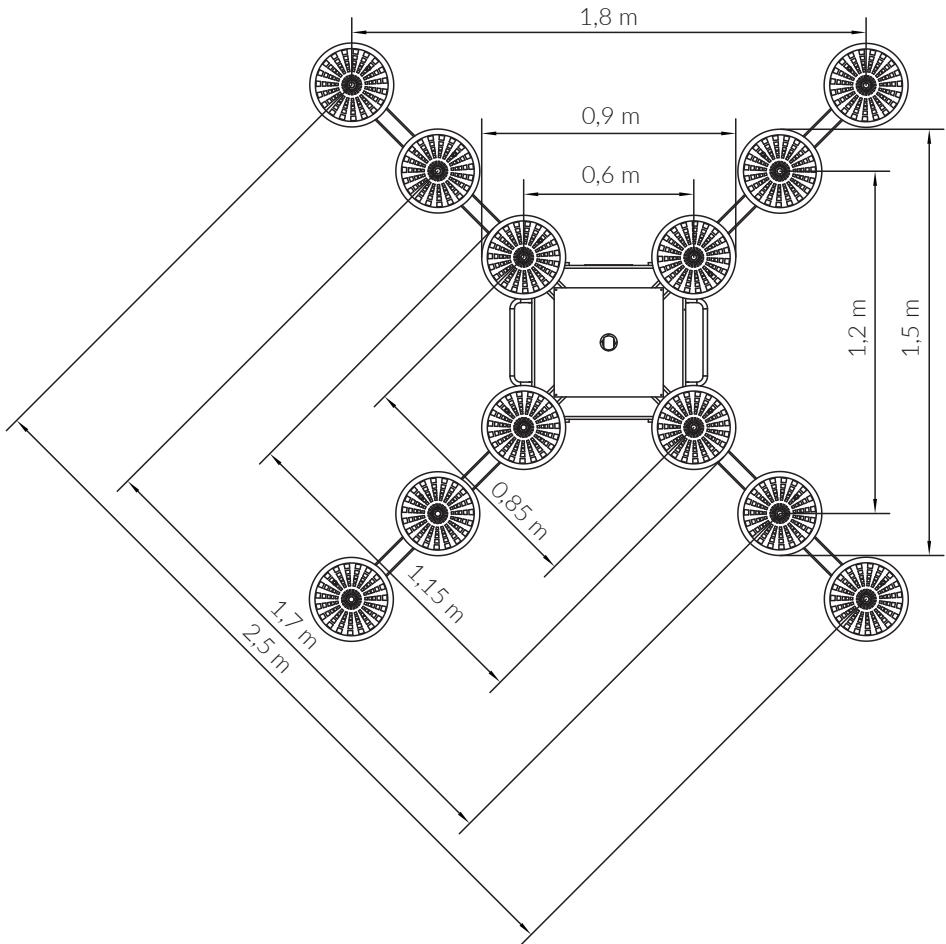

Lifting capacity:
900 kg



Number of
suction cups: 12



BEFARD XP 1000

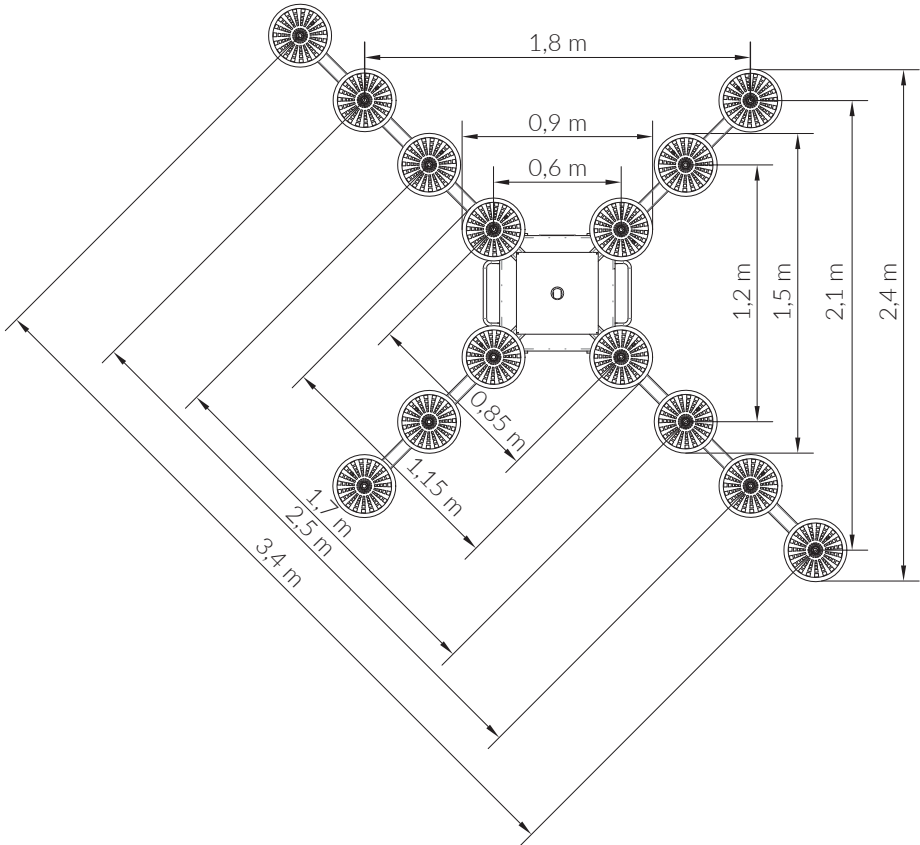

Lifting capacity:
1000 kg



Number of
suction cups: 14



